

E-Schweissbare Fittings

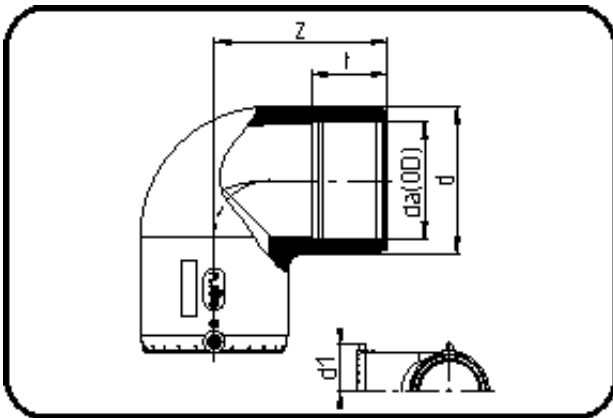

Code: 171

- E-Winkel 90°
- MOP Wasser 16bar / Gas 10bar
- W/P-TW
- formgespritzt
- **Heizwendelschweissung**
- **PE 100-RC schwarz**

Dimension	Code	Detail	Gewicht
40	70.171.0040.11	40 SDR 11	0.14

	Einheit	Nominale	Tol+	Tol-
da(OD)	mm	40	0.00	0.00
d	mm	53	0.75	0.75
d1	mm	49	1.50	1.50
t	mm	48	1.50	1.50
z	mm	75	2.25	2.25