

E-Schweissbare Fittings

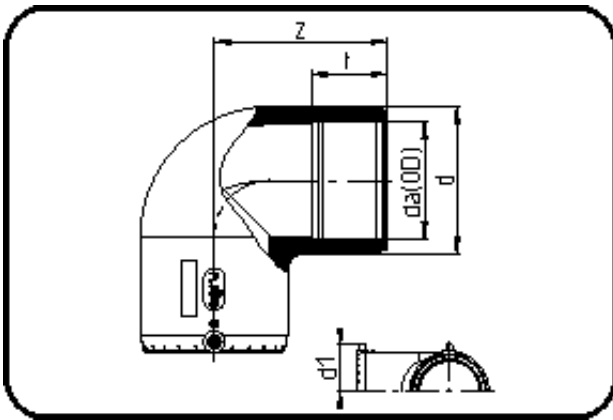

Code: 171

- E-Winkel 90°
- MOP Wasser 16bar / Gas 10bar
- W/P-TW
- formgespritzt
- **Heizwendelschweissung**
- **PE 100-RC schwarz**

Dimension	Code	Detail	Gewicht
32	70.171.0032.11	32 SDR 11	0.08

	Einheit	Nominale	Tol+	Tol-
da(OD)	mm	32	0.00	0.00
d	mm	42	0.75	0.75
d1	mm	44	1.50	1.50
t	mm	43	1.50	1.50
z	mm	65	2.25	2.25