

E-Schweissbare Fittings

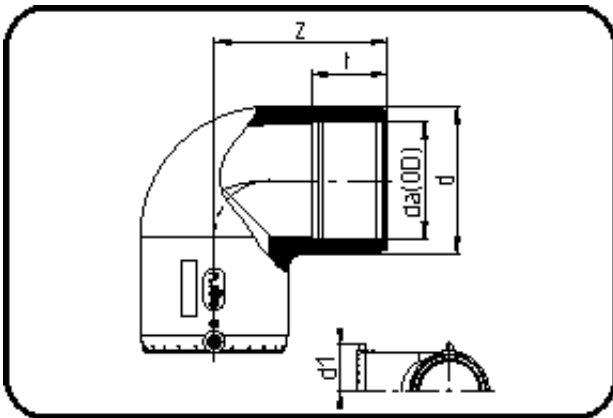

Code: 171

- E-Winkel 90°
- MOP Wasser 16bar / Gas 10bar
- W/P-TW
- formgespritzt
- **Heizwendelschweissung**
- **PE 100-RC schwarz**

Dimension	Code	Detail	Gewicht
160	70.171.0160.11	160 SDR 17-11	4.58

	Einheit	Nominale	Tol+	Tol-
da(OD)	mm	160	0.00	0.00
d	mm	200	1.50	1.50
d1	mm	109	1.50	1.50
t	mm	87	2.25	2.25
z	mm	222	2.25	2.25