

E-Schweissbare Fittings

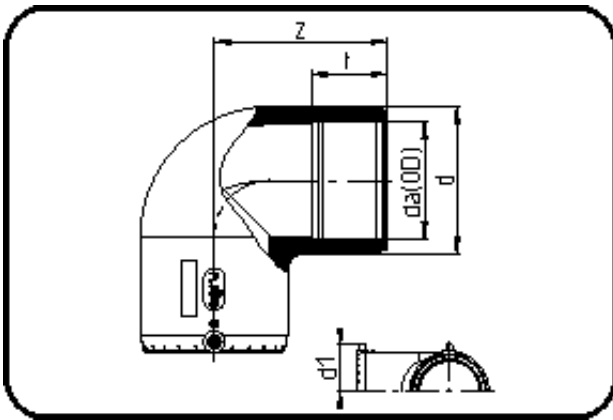

Code: 171

- E-Winkel 90°
- MOP Wasser 16bar / Gas 10bar
- W/P-TW
- formgespritzt
- **Heizwendelschweissung**
- **PE 100-RC schwarz**

Dimension	Code	Detail	Gewicht
125	70.171.0125.11	125 SDR 17-11	2.43

	Einheit	Nominale	Tol+	Tol-
da(OD)	mm	125	0.00	0.00
d	mm	161	1.50	1.50
d1	mm	91	1.50	1.50
t	mm	84	2.25	2.25
z	mm	164	2.25	2.25