

E-Schweissbare Fittings

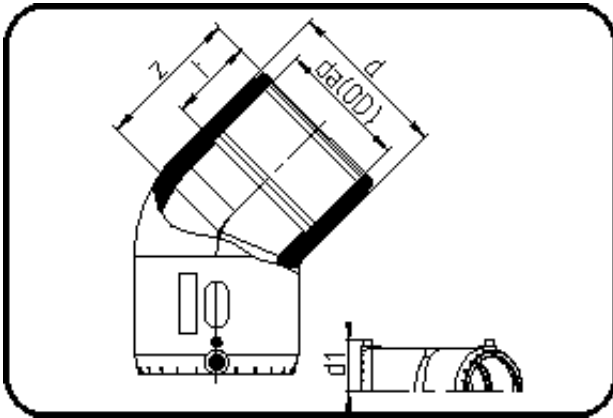

Code: 170

- E-Winkel 45°
- MOP Wasser 16bar / Gas 10bar
- W/P-TW
- formgespritzt
- Heizwendelschweissung
- PE 100-RC schwarz

Dimension	Code	Detail	Gewicht
140	70.170.0140.11	140 SDR 17-11	1.92

	Einheit	Nominale	Tol+	Tol-
da(OD)	mm	140	0.90	0.00
d	mm	173	1.00	1.00
d1	mm	97	1.00	1.00
t	mm	89	2.25	2.25
z	mm	128	1.50	1.50