

E-Schweissbare Fittings

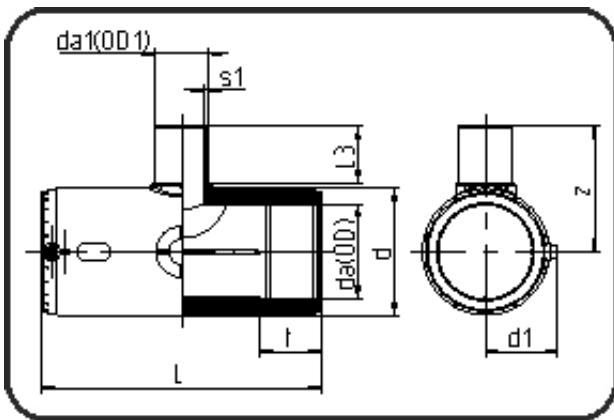

Code: 175

- E-T-Stück reduziert
- MOP Wasser 16bar / Gas 10bar
- W/P-TW
- formgespritzt
- Heizwendelschweissung
- PE 100-RC schwarz

Dimension	Code	Detail	Gewicht
40/25	70.175.4025.11	40/25 SDR 11	0.19

	Einheit	Nominale	Tol+	Tol-
da(OD)	mm	40	0.40	0.00
L	mm	138	4.50	0.00
L3	mm	42,5	2.25	2.25
d	mm	57,5	0.75	0.75
d1	mm	47,5	1.50	1.50
t	mm	47,5	1.50	0.00
s1	mm	3	0.40	0.00
da(OD1)	mm	25	0.30	0.00
z	mm	77	2.25	2.25