

## E-Schweissbare Fittings

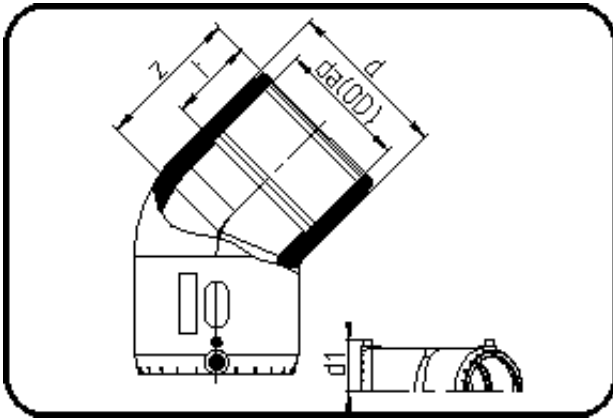

Code: 170

- E-Winkel 45°
- MOP Wasser 16bar / Gas 10bar
- W/P-TW
- formgespritzt
- **Heizwendelschweissung**
- **PE 100-RC schwarz**

Dimension	Code	Detail	Gewicht
90	70.170.0090.11	90 SDR 17-11	0.85

	Einheit	Nominale	Tol+	Tol-
da(OD)	mm	90	0.00	0.00
d	mm	115	1.50	1.50
d1	mm	74	1.50	1.50
t	mm	71	2.25	2.25
z	mm	113	2.25	2.25