

E-Schweissbare Fittings

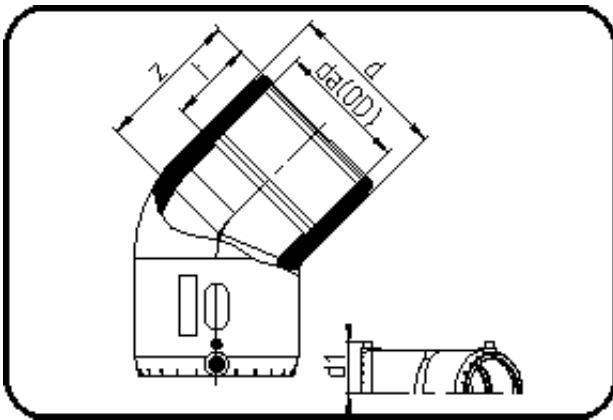

Code: 170

- E-Winkel 45°
- MOP Wasser 16bar / Gas 10bar
- W/P-TW
- formgespritzt
- **Heizwendelschweissung**
- **PE 100-RC schwarz**

Dimension	Code	Detail	Gewicht
75	70.170.0075.11	75 SDR 17-11	0.49

	Einheit	Nominale	Tol+	Tol-
da(OD)	mm	75	0.00	0.00
d	mm	97	0.75	0.75
d1	mm	66	1.50	1.50
t	mm	68,5	2.25	2.25
z	mm	94	2.25	2.25